

HRTR 55 "XL"

Diffuse reflection light scanner with background suppression

en 05-2013/03 50107829-02



Dimensioned drawing

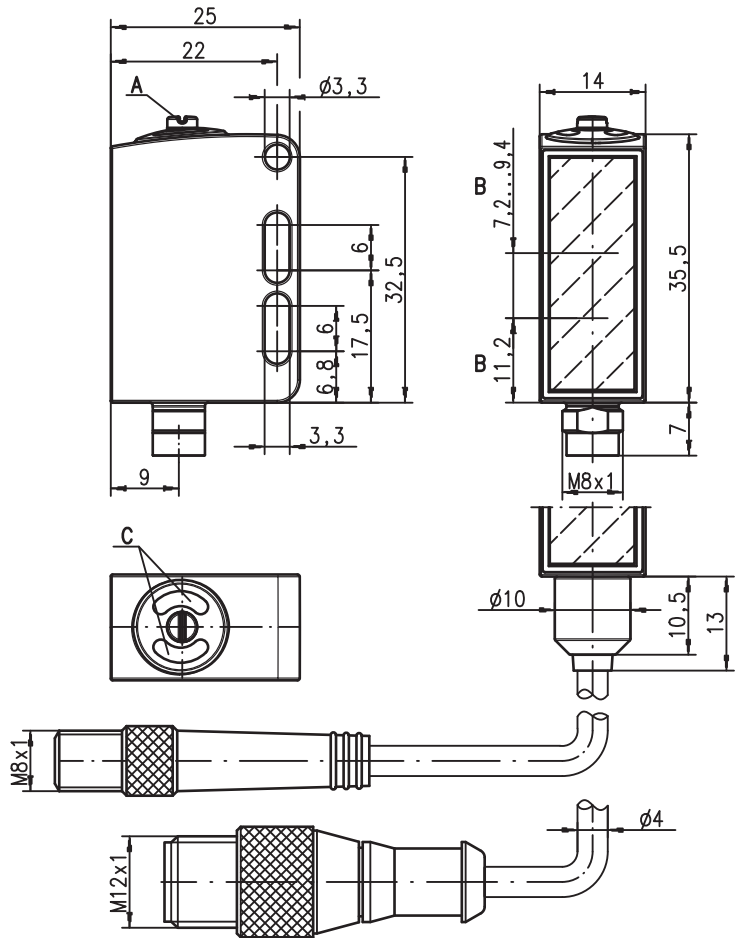

- A Adjustment screw
- B Optical axis
- C Indicator diode

Electrical connection

Plug connection, 4-pin (with/without cable)

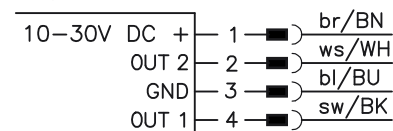

Plug connection, 3-pin

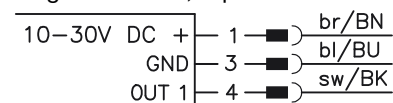

5 ... 100mm
60mm with
black-white error < 10%



- Diffuse reflection light scanner with visible red light and adjustable background suppression
- 316L stainless steel housing in Hygiene-Design
- Enclosed optics design prevents bacterial carry-overs
- ECOLAB and CleanProof+ tested
- Paperless device identification
- Scratch resistant and non-diffusive plastic front cover
- Wide, rectangular light spot guarantees the reliable detection of:
 - objects with openings, holes and grooves
 - transparent foils and bottles
 - objects with grid structures (e.g. blister packs)
 - objects with variable position
- A²LS- Active Ambient Light Suppression
- Push-pull switching outputs
- High switching frequency for detection of fast events



Accessories:

(available separately)

- Cable with M8 or M12 connector (K-D ...)
- Cable for food and beverages
- Mounting devices

We reserve the right to make changes • DS_HRTR55XL_en_50107829-02.fm

Specifications

Optical data

Typ. scanning range limit ¹⁾	5 ... 100mm
Scanning range ²⁾	see tables
Adjustment range	20 ... 100mm
Light spot	approx. 3 x 40mm ² at 50mm
Light source ³⁾	LED (modulated light)
Wavelength	620nm (visible red light)

Timing

Switching frequency	1000Hz
Response time	0.5ms
Delay before start-up	≤ 300ms (acc. to. IEC 60947-5-2)

Electrical data

Operating voltage U _B ⁴⁾	10 ... 30VDC (incl. residual ripple)
Residual ripple	≤ 15% of U _B
Open-circuit current	≤ 15mA
Switching output	.../66 ⁵⁾ 2 push-pull switching outputs pin 2: PNP dark switching, NPN light switching pin 4: PNP light switching, NPN dark switching .../22 2 NPN switching outputs, complementary .../44 2 PNP switching outputs, complementary .../6 ⁵⁾ 1 push-pull switching output pin 4: PNP light switching, NPN dark switching light/dark switching
Function characteristics	≥ (U _B - 2V) / ≤ 2V
Signal voltage high/low	max. 100mA
Output current	adjustable via 8-turn potentiometer
Scanning range	

Indicators

Green LED	ready
Yellow LED	object detected - reflection

Mechanical data

Housing	AISI 316L stainless steel, DIN X2CrNiMo17132, W.No1.4404
Housing design	WASH-DOWN-Design
Housing roughness ⁶⁾	Ra ≤ 2.5
Connector	AISI 316L stainless steel, DIN X2CrNiMo17132, W.No1.4404
Optics cover	coated plastic (PMMA), scratch resistant and non-diffusive
Operation	plastic (TPV - PE), non-diffusive
Weight	with M8 connector: 40g with 200mm cable and M12 connector: 60g with 5000mm cable: 110g
Connection type	M8 connector, 4-pin, 0.2m cable with M12 connector, 4-pin, 5m cable, 4 x 0.20mm ²

Environmental data

Ambient temp. (operation/storage) ⁷⁾	-30°C ... +70°C / -30°C ... +70°C
Protective circuit ⁸⁾	2, 3
VDE safety class ⁹⁾	III
Protection class	IP 67, IP 69K ¹⁰⁾
Environmentally tested acc. to	ECOLAB, CleanProof+
LED class	1 (acc. to EN 60825-1)
Standards applied	IEC 60947-5-2
Certifications	UL 508 ⁴⁾
Chemical resistance	tested in accordance with ECOLAB and CleanProof+ (see remarks)

- 1) Typ. scan. range limit: max. achievable scanning range for light objects (white 90%)
- 2) Scanning range: recommended scanning range for objects with different diffuse reflection
- 3) Average life expectancy 100,000h at an ambient temperature of 25°C
- 4) For UL applications: for use in class 2 circuits according to NEC only
- 5) The push-pull switching outputs must not be connected in parallel
- 6) Typical value for the stainless steel housing
- 7) Operating temperatures of +70°C permissible only briefly (≤ 15min)
- 8) 2=polarity reversal protection, 3=short-circuit protection for all transistor outputs
- 9) Rating voltage 50V
- 10) Only in combination with M12 connector

Approved purpose

The light scanners are optical electronic sensors for optical, contactless detection of objects. This product may only be used by qualified personnel and must only be used for the approved purpose. This sensor is not a safety sensor and is not to be used for the protection of persons.

Tables

1	5	100
2	5	90
3	5	80

1	white 90%
2	gray 18%
3	black 6%

Scanning range [mm]
Typ. scanning range limit [mm]

Diagrams

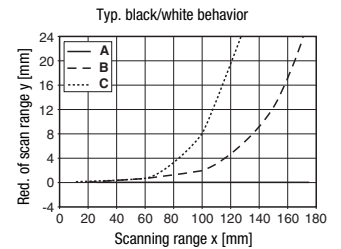
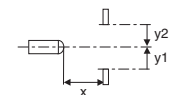
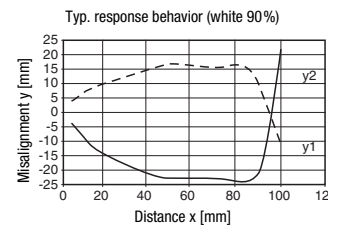

- A white 90%
- B gray 18%
- C black 6%

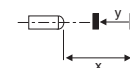

Remarks

A list of tested chemicals can be found in the first part of the product description.

HRTR 55 "XL"

Diffuse reflection light scanner with background suppression

Order guide

Selection table		Order code →						
Equipment ↓		HRTR 55/44-XL-5000 Part No. 50116828	HRTR 55/22-XL-5000 Part No. 50117199	HRTR 55/66-XL-5000 Part No. 50114070	HRTR 55/66-XL-S8 Part No. 50107496	HRTR 55/6-XL-S8.3 Part No. 50107497	HRTR 55/66-XL-200-S12 Part No. 50107498	
Switching output	2 x PNP output, complementary	●						
	2 x NPN output, complementary		●					
	2 x Push-pull switching output			●	●		●	
	1 x Push-pull switching output					●		
Switching function	1 PNP light switching and NPN dark switching output			●	●	●	●	
	1 PNP dark switching and NPN light switching output			●	●		●	
Connection	M8 connector, metal, 4-pin				●			
	M8 connector, metal, 3-pin					●		
	200mm cable with M12 connector, 4-pin						●	
	5000mm cable, 4-pin	●	●	●				
Indicators	Green LED: ready	●	●	●	●	●	●	
	Gellow LED: switching output	●	●	●	●	●	●	

Application notes



- For glossy surfaces (e.g. metals), the light beam should not be incident on the object surface at a right angle. A slight inclination is sufficient for preventing undesired direct reflections. This may result in a reduction in the scanning range.
- Objects should only be moved in laterally from the right or left. Moving in objects from the connector side or operating side is to be avoided.
- Outside of the scanning range, the sensor operates as an energetic diffuse reflection light scanner. Light objects can still be reliably detected up to the scanning range limit.
- The sensors are equipped with effective measures for the maximum avoidance of mutual interference should they be mounted opposite one another. Opposite mounting of multiple sensors of the same type should, however, absolutely be avoided.

